



# Memoirs® Stately

Drop-in Bathroom Sink  
K-2337-4

## Features

- 4-inch center faucet holes.
- Elegant rectangular basin.
- Overflow drain.
- Coordinates with other products in the Memoirs collection.

## Material

- Vitreous china.

## Installation

- Drop-in

## Recommended Products/Accessories

K-8998 P-Trap



ADA

## Codes/Standards













ASME A112.19.2/CSA B45.1  
ADA  
ICC/ANSI A117.1

## KOHLER® One-Year Limited Warranty

See website for detailed warranty information.

## Available Colors/Finishes

*Color tiles intended for reference only.*

Color	Code	Description
	0	White
	96	Biscuit
	47	Almond
	NY	Dune
	95	Ice™ Grey
	G9	Sandbar
	K4	Cashmere
	58	Thunder™ Grey
	7	Black Black™
	89	Desert Bloom
	S3	Stoneware
	S4	White Cliffs
	V2	Cream City

1-800-4KOHLER (1-800-456-4537)

Kohler Co. reserves the right to make revisions without notice to product specifications.

For the most current Specification Sheet, go to [www.kohler.com](http://www.kohler.com).

1-31-2019 12:28 - US/CA

THE BOLD LOOK  
OF **KOHLER**®

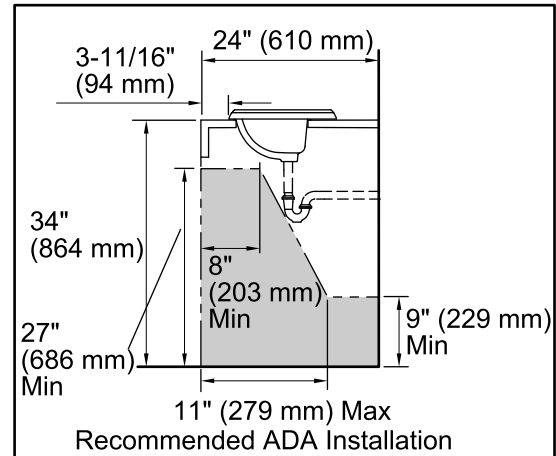
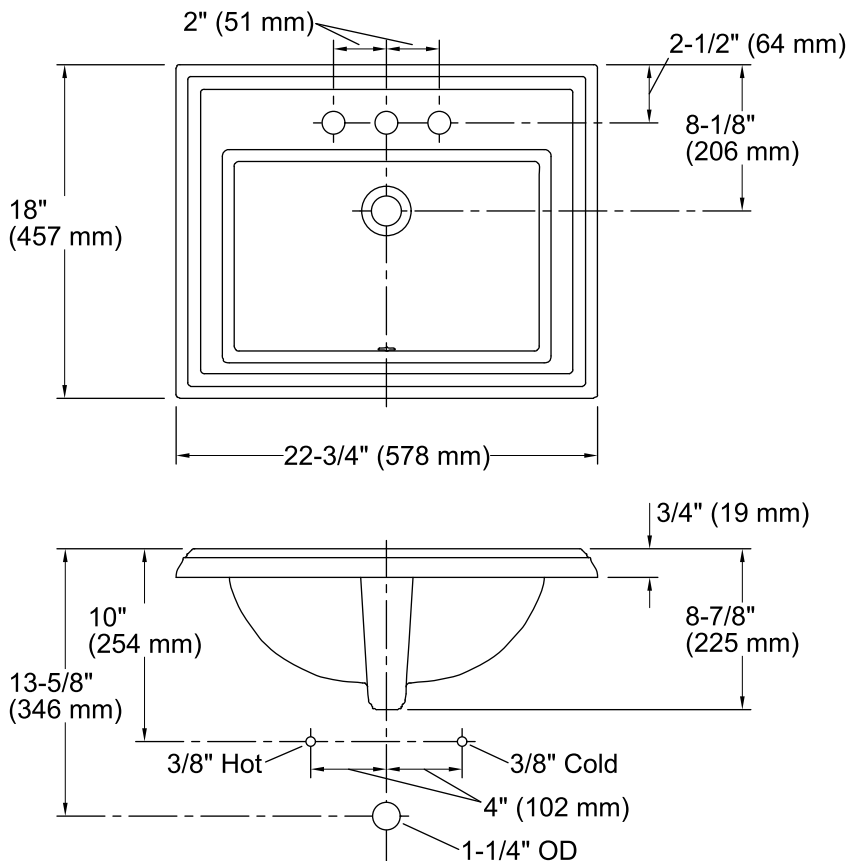

### Technical Information

All product dimensions are nominal.

Bowl configuration:	Single
Installation:	Drop-in
Bowl area (Only):	Length: 17" (432 mm) Width: 10" (254 mm) Water depth: 5" (127 mm)
Number of deck holes:	3
Faucet hole spacing:	4" (102 mm)
Faucet hole(s):	1-1/4" (32 mm)
Drain hole:	1-3/4" (44 mm)
Template:	1003676, required, included

### Notes

Install this product according to the installation instructions.

**NOTICE:** Countertop manufacturer or cutter must use the cut-out template provided with the product, or a current one provided by Kohler Co. (call 1-800-4KOHLER). Kohler Co. is not responsible for cut-out errors when incorrect cut-out template is used.

ADA compliant when installed to the specific requirements of these regulations.