

### Features

- For single-hole installation or 4-inch centers with escutcheon (add "optional" escutcheon plate included).
- KOHLER ceramic disc valves exceed industry longevity standards two times for a lifetime of durable performance.
- KOHLER finishes resist corrosion and tarnishing, exceeding industry durability standards two times.
- Completes Devonshire design solution with KOHLER fixtures and accessories.
- Temperature memory allows faucet to be turned on and off at any temperature setting

### Material

- Premium material construction for durability and reliability.

### Installation

- Pop-up drain with lift rod and tailpiece
- Flexible connections for easy installation

### Water Conservation & Rebates

- Low-flow aerator option available (please see latest price book).
- 1.2 gal/min (4.5 l/min) maximum flow rate [max at 60 psi (4.14 bar)].

### Adapters, Rough-in and Extension Kits

1223297\_1



**ADA** **CSA B651** **OBC**

### Codes/Standards

ASME A112.18.1/CSA B125.1

NSF/ANSI 61

NSF/ANSI 372

All applicable US Federal and State material regulations

DOE - Energy Policy Act 1992

EPA WaterSense®

California Energy Commission (CEC)

ADA

ICC/ANSI A117.1

CSA B651







OBC

### KOHLER® Faucet Lifetime Limited Warranty

See website for detailed warranty information.

### Available Colors/Finishes

*Color tiles intended for reference only.*

Color	Code	Description
	CP	Polished Chrome
	SN	Vibrant® Polished Nickel
	PB	Vibrant® Polished Brass
	BN	Vibrant® Brushed Nickel
	BV	Vibrant® Brushed Bronze
	2BZ	Oil-Rubbed Bronze

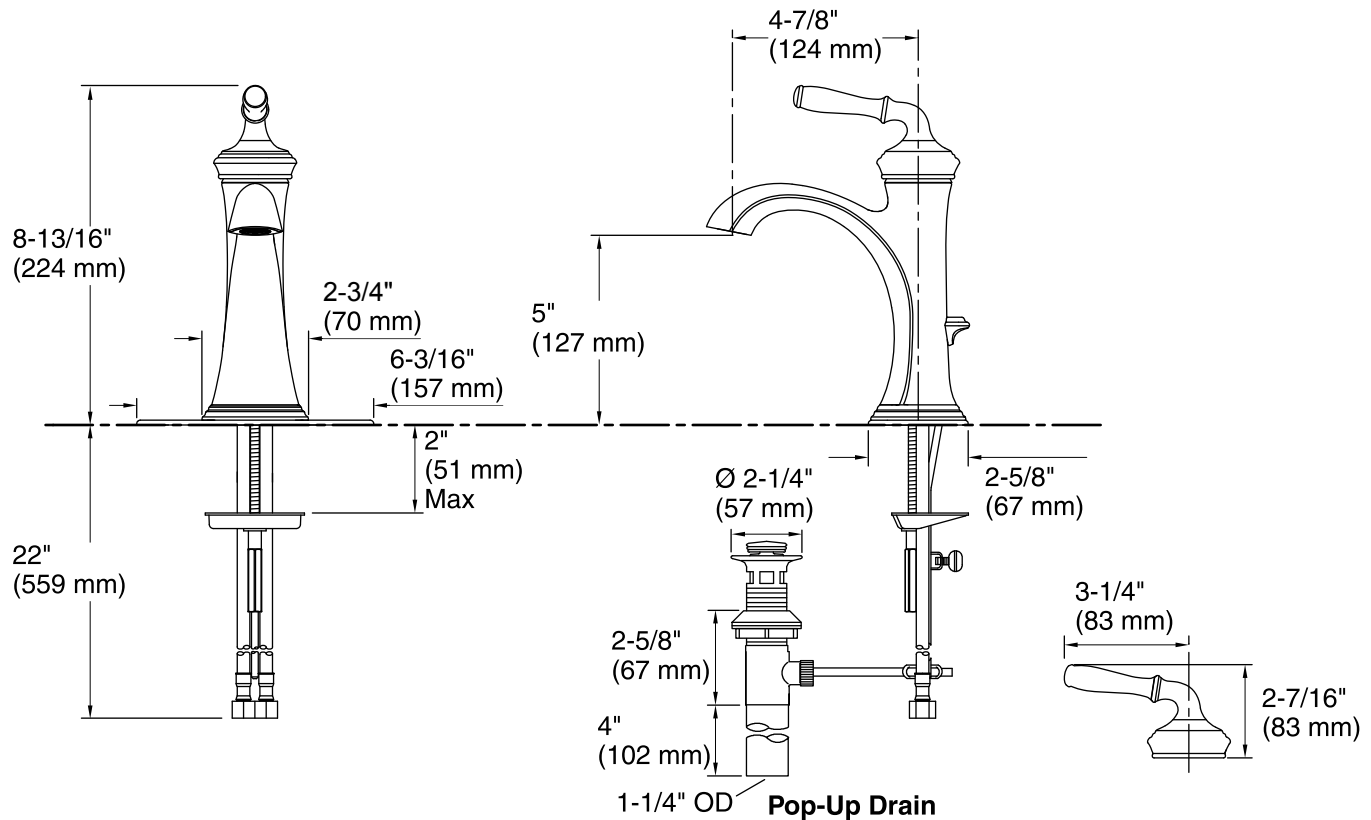

### Technical Information

All product dimensions are nominal.

#### Faucet:

Flow rate: 1.2 gal/min (4.5 l/min)

Pressure: 60 psi (4.1 bar)

Drain included: Yes

Drain tailpiece included: Yes

#### Spout:

Spout reach: 4-7/8" (124 mm)

### Notes

Install this product according to the installation guide.

ADA, OBC, CSA B651 compliant when installed to the specific requirements of these regulations.