

Features

- One-piece toilets integrate the tank and bowl into a seamless, easy-to-clean design.
- Compact elongated bowl offers added comfort while occupying the same space as a round-front bowl.
- Comfort Height® feature offers chair-height seating that makes sitting down and standing up easier for most adults.
- 1.28 gallons per flush (gpf).
- Skirted trapway simplifies cleaning.
- Standard left-hand Polished Chrome trip lever included.
- Glenbury™ Quiet-Close™ seat with Grip-Tight allows seat to close quietly and quickly unlatch from the toilet for easy removal and convenient cleaning.
- Patented ReadyLock™ installation system is a simple solution for skirted toilets that saves time, hassle, and eliminates the need to drill into the floor for a standard 12-inch rough-in.
- Coordinates with other products in the Tresham collection.

Technology

- Single-flush gravity uses the force of gravity and a precision-engineered tank, bowl, and trapway to create a strong siphon during flushing.
- AquaPiston canister allows water to flow into the bowl from all sides (360 degrees), increasing the power and effectiveness of the flush.
- Flush valve's 3:2 ratio harnesses the natural force of gravity and optimizes flush performance.
- Durable canister design has 90% less exposed seal material than a 3-inch flapper, for leak-free performance.
- Light-touch canister flush requires a lower actuation force than a flapper.

Installation

- Standard 12-inch rough-in.
- 10-inch and 14-inch rough-in kits are also available.
- Supply line not included.

Water Conservation & Rebates

- WaterSense® toilets meet strict EPA flushing guidelines, including using at least 20 percent less water than 1.6-gallon toilets.
- Eligible for consumer rebates in some municipalities.
- This product meets water savings requirements for California Energy Commission (CEC), CALGreen, and Colorado SB 14-103.

Recommended Accessories

K-75796 Cachet® Nightlight Quiet-Close™ Elongated Toilet Seat
 K-4108 C3®-230 Elongated Cleansing Toilet Seat
 K-5381 14" Rough-in Full Skirt Trap and Attachment System



ADA **CSA B651** **OBC**

Codes/Standards











ASME A112.19.2/CSA B45.1
 DOE - Energy Policy Act 1992
 EPA WaterSense®
 California Energy Commission (CEC)
 ADA
 ICC/ANSI A117.1
 CSA B651
 OBC

KOHLER® One-Year Limited Warranty

See website for detailed warranty information.

Available Color/Finishes

Color tiles intended for reference only.

Color	Code	Description
	0	White
	96	Biscuit
	47	Almond
	NY	Dune
	95	Ice™ Grey
	G9	Sandbar
	33	Mexican Sand™
	K4	Cashmere
	58	Thunder™ Grey
	7	Black Black™

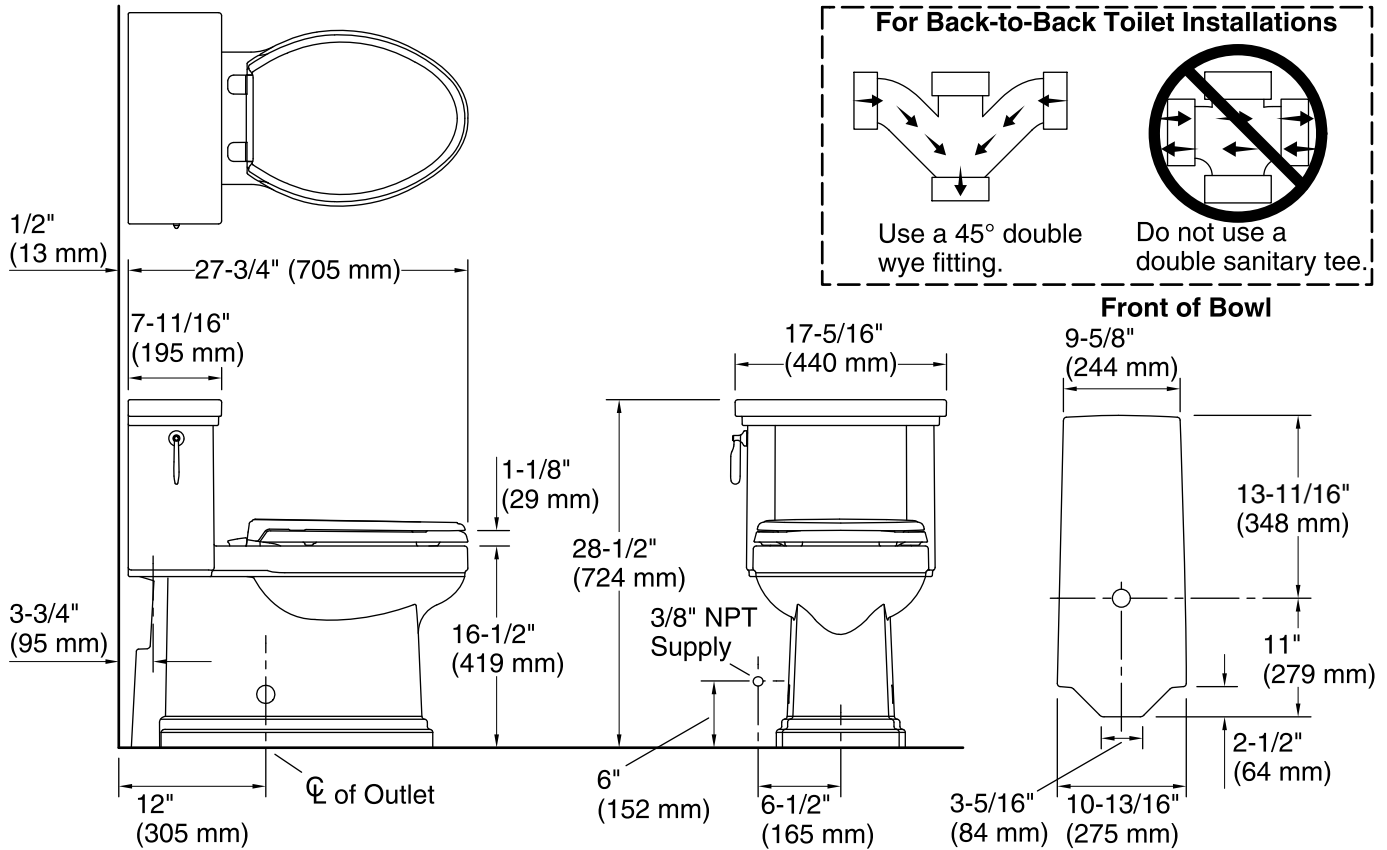

Technical Information

All product dimensions are nominal.

Toilet type:	One-piece
Bowl shape:	Compact Elongated front
Seat hinge type:	Quick-Attach®, Quiet-Close™, Quick-Release™
Trap passageway:	2-1/8" (54 mm)
Water Consumption	
Full:	1.28 gpf (4.8 lpf)
Water surface size:	9-5/8" x 6-7/8" (245 mm x 174 mm)
Rim to water surface:	5-3/8" (137 mm)
Rough-in:	12
Seat-mounting holes:	5-1/2" (140 mm)

Notes

Install this product according to the installation instructions.

For back-to-back toilet installations: Use only a 45° double wye fitting.

ADA, OBC, CSA B651 compliant when installed to the specific requirements of these regulations.

Plumbing codes may require elongated toilets and elongated, open-front seats in public bathrooms.

Accessibility standards may require controls to be located on the open side of the toilet.