

Features

- Freestanding design creates a striking focal point in your bathing area.
- 16-inch soaking depth.
- Sloped lumbar support offers extra comfort while bathing.
- Integral slotted overflow allows for deep soaking.
- Center toe-tap drain with KOHLER Lithocast® Gloss cover.
- Coordinates with other products in the Veil collection.

Material

- KOHLER Lithocast® Gloss cast resin.

Installation

- Freestanding
- Above-the-floor drain (AFD) installation option offers quick installation that does not require floor clearance for drain.



Codes/Standards

CSA B45.5/IAPMO Z124

KOHLER® One-Year Limited Warranty

See website for detailed warranty information.

Available Colors/Finishes

Color tiles intended for reference only.

Color	Code	Description
-------	------	-------------

	0	White
--	---	-------

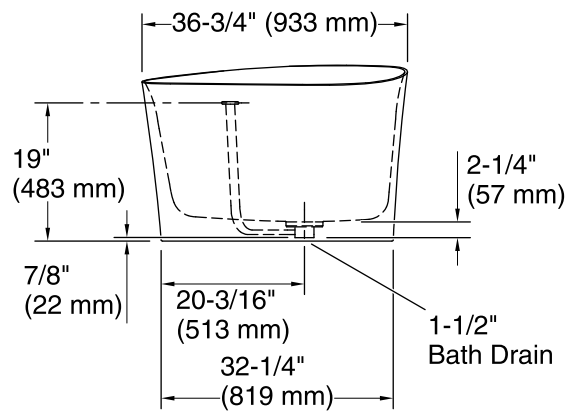
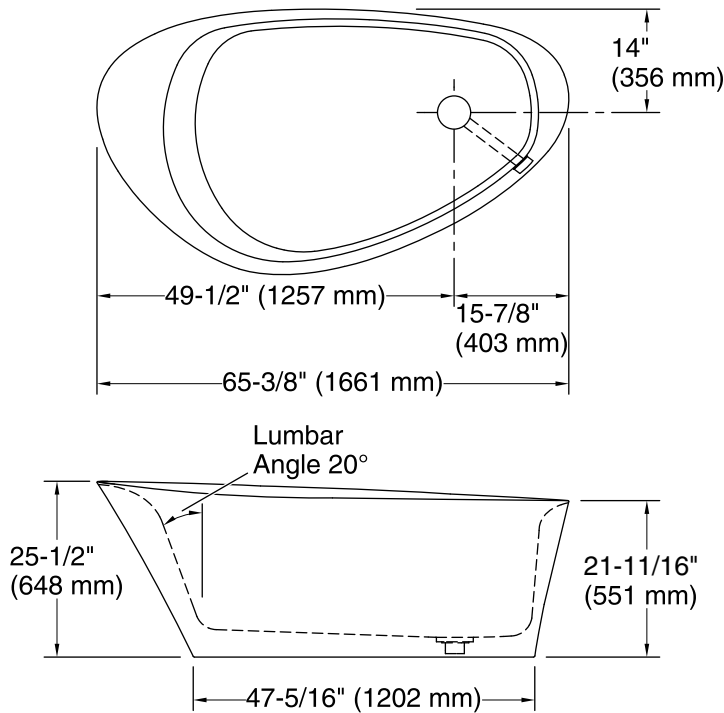

Technical Information

All product dimensions are nominal.

Installation:	Freestanding
Drain location:	Center
Basin area, bottom:	46-9/16" x 22-3/8" (1183 mm x 568 mm)
Basin area, top:	64-7/16" x 36-1/4" (1637 mm x 921 mm)
Weight:	270 lbs (122.5 kg)
Minimum floor load:	91.8 lbs/ft ² (448.2 kg/m ²)
Water depth:	15-7/8" (404 mm)
Water capacity:	84.29 gal (319.1 L)
Template:	Footprint, 1314992, not required, not included

Notes

Measure your actual product for rough-in details. Install this product according to the installation instructions.

The hot water supply should be 70% of the capacity of the bath or greater. Installations will vary.

Allow for 3" (76 mm) diameter of clearance around the drain pipe on finished floor material to prevent drain body interference during installation.