



Features

- Low-threshold design for easy entry and exit.
- Single threshold for three-wall installation.
- Durable Acrylic construction.
- Center drain.
- Coordinates with other products in the Tresham collection.

Recommended Products/Accessories

- K-1733 9 kW Steam Generator
- K-9132 Shower Drain
- K-702208-G54 Frameless Sliding Shower Door
- K-702208-G73 Frameless Sliding Shower Door
- K-702208-L Frameless Sliding Shower Door
- K-702209-L Frameless Sliding Shower Door
- K-705704-L Frameless Pivot Shower Door
- K-705710-L Frameless Pivot Shower Door
- K-705716-L Frameless Pivot Shower Door
- K-705722-L Frameless Pivot Shower Door
- K-705728-L Frameless Pivot Shower Door
- K-705740-L Frameless Pivot Shower Door
- K-705808-L Semi-Frameless Pivot Shower Door
- K-705809-L Semi-Frameless Pivot Shower Door
- K-705822-L Semi-Frameless Pivot Shower Door
- K-705823-L Semi-Frameless Pivot Shower Door
- K-706008-D3 Frameless Sliding Shower Door
- K-706008-L Frameless Sliding Shower Door
- K-706010-L Frameless Sliding Shower Door
- K-706011-L Frameless Sliding Shower Door
- K-706014-D3 Frameless Sliding Shower Door
- K-706014-L Frameless Sliding Shower Door
- K-706016-L Frameless Sliding Shower Door
- K-706017-L Frameless Sliding Shower Door



Codes/Standards







- CSA B45.5/IAPMO Z124
- ASTM E162
- ASTM E662
- Greenguard UL 2818 - Gold

KOHLER® Plastic Baths and Receptors Lifetime Limited Warranty

See website for detailed warranty information.

Available Colors/Finishes

Color tiles intended for reference only.

Color	Code	Description
	0	White
	96	Biscuit
	47	Almond
	NY	Dune
	95	Ice™ Grey
	G9	Sandbar

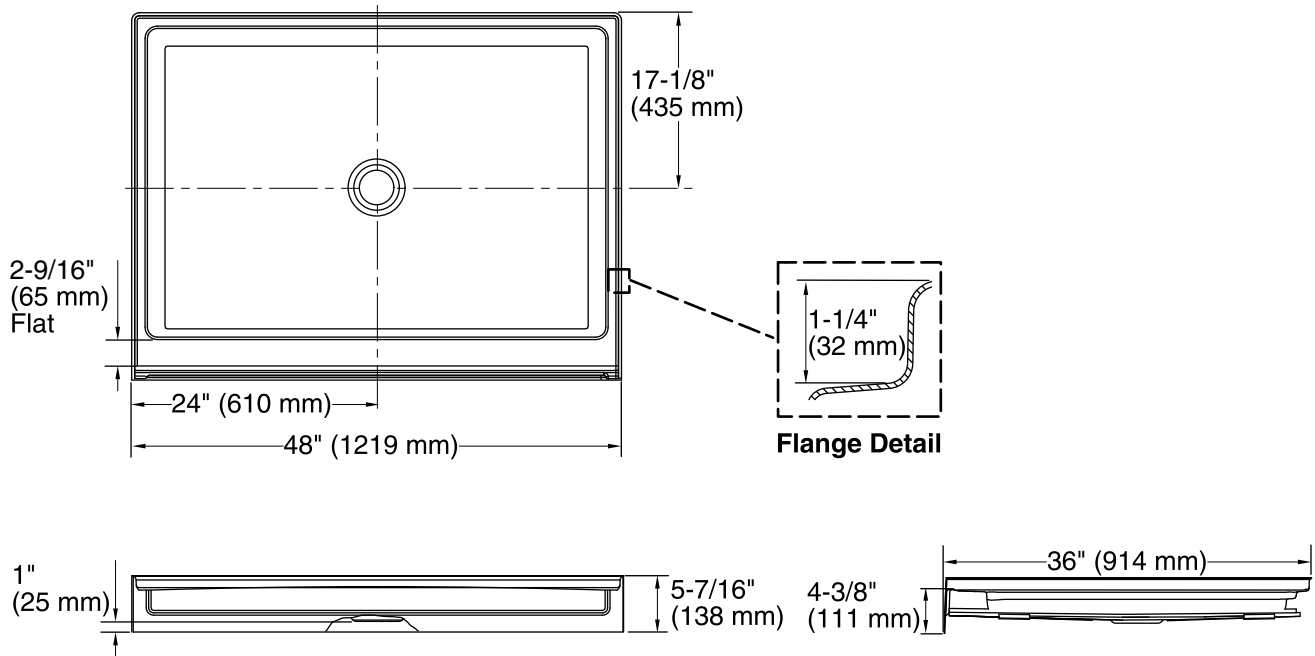

Technical Information

All product dimensions are nominal.

Installation:	Three-wall alcove
Drain location:	Center
Weight:	52 lbs (23.6 kg)
Minimum floor load:	20 lbs/ft ² (97.6 kg/m ²)

Notes

Measure your actual product for rough-in details.

Install this product according to the installation instructions.

Shimming may be required between the stud frame and the fixture.

Stud opening tolerance is +1/4" (6 mm), -0" (0 mm).

KOHLER steam generator/control kit are designed for use with this product. Kohler Co. shall not be responsible for problems encountered due to the installation and use of other manufacturer's steam generators.