

### Features

- 1/2" NPT connections
- Available 27- or 54-nozzle configurations
- 2 gallons (7.6 L) per minute flow rate at 80 psi (552.6 kPA)



### Codes/Standards













ASME A112.18.1/CSA B125.1  
DOE - Energy Policy Act 1992

### KOHLER® Faucet Lifetime Limited Warranty

See website for detailed warranty information.

### Available Colors/Finishes

*Color tiles intended for reference only.*

Color	Code	Description
	CP	Polished Chrome
	SN	Vibrant® Polished Nickel
	AF	Vibrant® French Gold
	PGD	Vibrant® Moderne Polished Gold
	BGD	Vibrant® Moderne Brushed Gold
	G	Brushed Chrome
	BN	Vibrant® Brushed Nickel
	BV	Vibrant® Brushed Bronze
	2BZ	Oil-Rubbed Bronze
	BL	Matte Black
	TT	Titanium
	VNT	Vintage Nickel

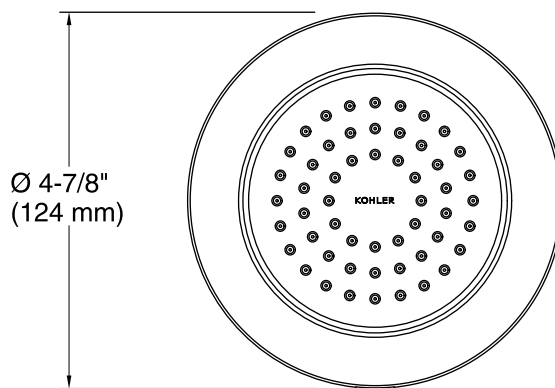
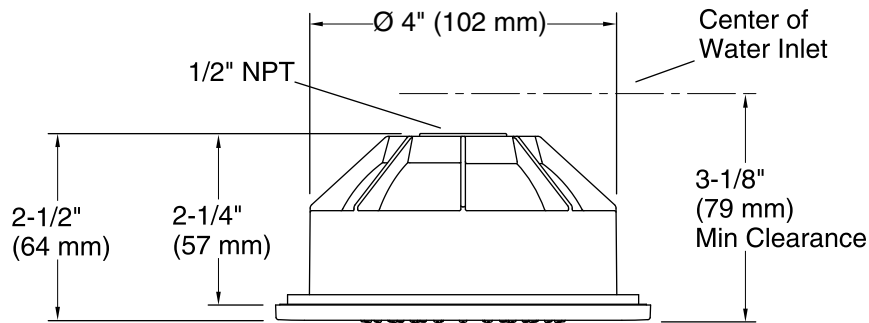

### Technical Information

All product dimensions are nominal.

### Notes

Install this product according to the installation instructions.