

Features

- Catalyzed conversion varnish provides a durable moisture-resistant finish.
- Two doors.
- Frameless construction with full-overlay doors.
- Three-way adjustable slow-close door hinges with 110-degree opening capability for easy cabinet access.
- Wall-hung design offers a clean, streamlined look.
- Coordinates with the K-99686 Damask knob and K-99689 Damask handle (sold separately).
- Combines with Ceramic/Impressions®, Solid/Expressions™, and Iron/Impressions™ vanity tops (sold separately) for a complete vanity.
- Customize your storage with optional in-door accessories and medicine cabinet surrounds and side kits (sold separately).

Material

- Solid wood and veneers.
- Wood is a living material, and its beauty is enhanced by natural variations in grain, color, and pattern. No two pieces of wood are exactly the same, and the color will change with age, temperature, and exposure to light.
- The nature of wood grain can cause variations in stain depth. Our expert craftspeople hand-apply the stain to blend these variations.

Recommended Products/Accessories

K-2777-1 Vanity Top Bathroom Sink
 K-2777-8 Vanity Top Bathroom Sink
 K-99689 Handle
 K-5421 Bathroom Vanity Top
 K-5436 Bathroom Vanity Top
 K-5455 Bathroom Vanity Top
 K-2791-1 Vanity Top Bathroom Sink
 K-2791-8 Vanity Top Bathroom Sink
 K-99738 Appliance Tray
 K-99675 Medicine Cabinet Wood Side Kit
 K-99686 Knob
 K-3048-1 Vanity-top Bathroom Sink
 K-3048-4 Vanity-top Bathroom Sink
 K-3048-8 Vanity-top Bathroom Sink



Codes/Standards









EPA TSCA Title VI
 CARB P2

KOHLER® One-Year Limited Warranty

See website for detailed warranty information.

Available Colors/Finishes

Color tiles intended for reference only.

Color	Code	Description
	1WA	Linen White
	1WF	Khaki White Oak
	1WD	Ramie Walnut
	1WG	Cherry Tweed
	1WB	Claret Suede
	1WC	Felt Grey
	1WE	Terry Walnut
	1WT	Mohair Grey
	1WU	Batiste Black

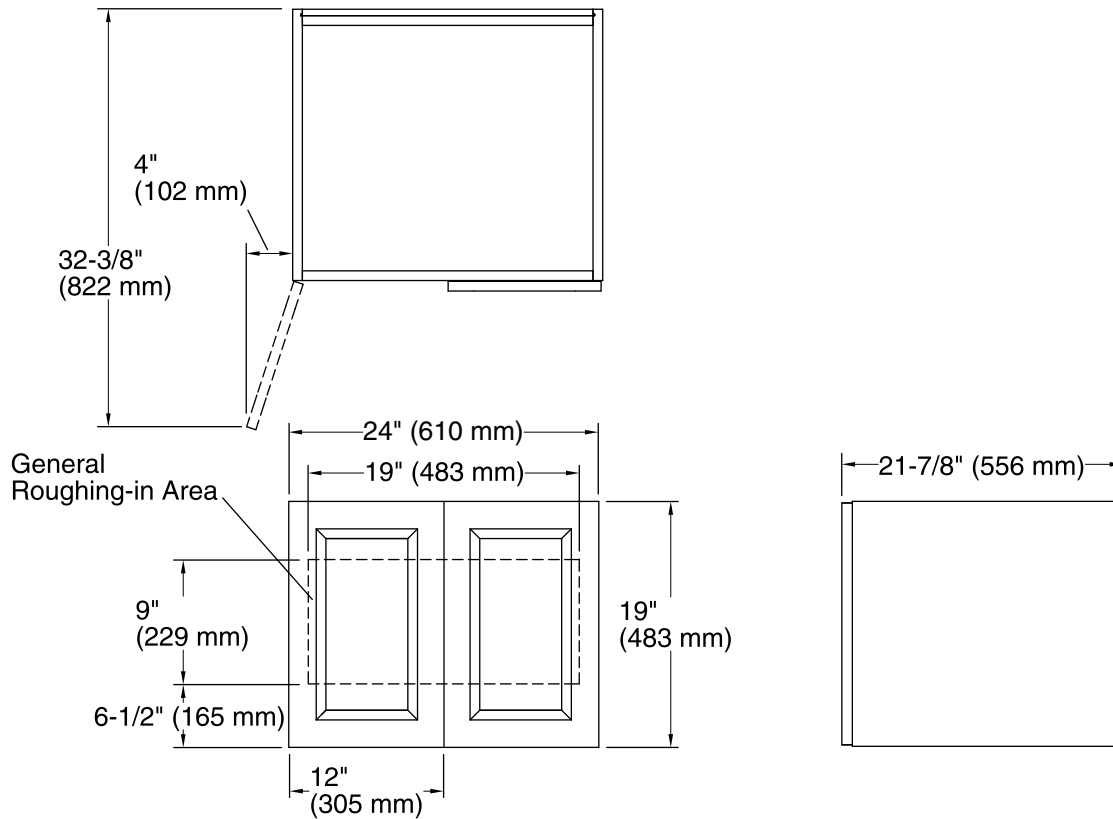

Technical Information

All product dimensions are nominal.

Vanity type: Wall-mount

Notes

Install this product according to the installation guide.

Decorative cabinet hardware is not supplied. Refer to the KOHLER bath accessories line for recommended cabinet hardware to complement your vanity.

To properly support the weight of the vanity and sink, secure to stud framing or 2x6 bracing behind the finished wall.

Select 500 lb (227 kg) load bearing 5/16" lag bolts with a length to clear obstacles in the wall and 5/16" washers.

Plan for electrical service if installing the optional electrical strip. Any electrical accessory components must be connected to a circuit protected by a Ground-Fault Circuit-Interrupter (GFCI) or Residual Current Device (RCD).