

Features

- Catalyzed conversion varnish provides a durable moisture-resistant finish.
- Two doors.
- Frameless construction with full-overlay doors.
- Three-way adjustable slow-close door hinges with 110-degree opening capability for easy cabinet access.
- Legs offer the polished look of furniture in the bath.
- Coordinates with the K-99686 Damask knob and K-99689 Damask handle (sold separately).
- Combines with Ceramic/Impressions®, Solid/Expressions™, and Iron/Impressions™ vanity tops (sold separately) for a complete vanity.
- Customize your storage with optional in-door accessories and medicine cabinet surrounds and side kits (sold separately).

Material

- Solid wood and veneers.
- Wood is a living material, and its beauty is enhanced by natural variations in grain, color, and pattern. No two pieces of wood are exactly the same, and the color will change with age, temperature, and exposure to light.
- The nature of wood grain can cause variations in stain depth. Our expert craftspeople hand-apply the stain to blend these variations.



Codes/Standards











EPA TSCA Title VI
CARB P2

KOHLER® One-Year Limited Warranty

See website for detailed warranty information.

Available Colors/Finishes

Color tiles intended for reference only.

| Color | Code | Description |
|--|------|-----------------|
|  | 1WA | Linen White |
|  | 1WF | Khaki White Oak |
|  | 1WD | Ramie Walnut |
|  | 1WG | Cherry Tweed |
|  | 1WB | Claret Suede |
|  | 1WH | Woolen Oak |
|  | 1WC | Felt Grey |
|  | 1WE | Terry Walnut |
|  | 1WT | Mohair Grey |
|  | 1WU | Batiste Black |

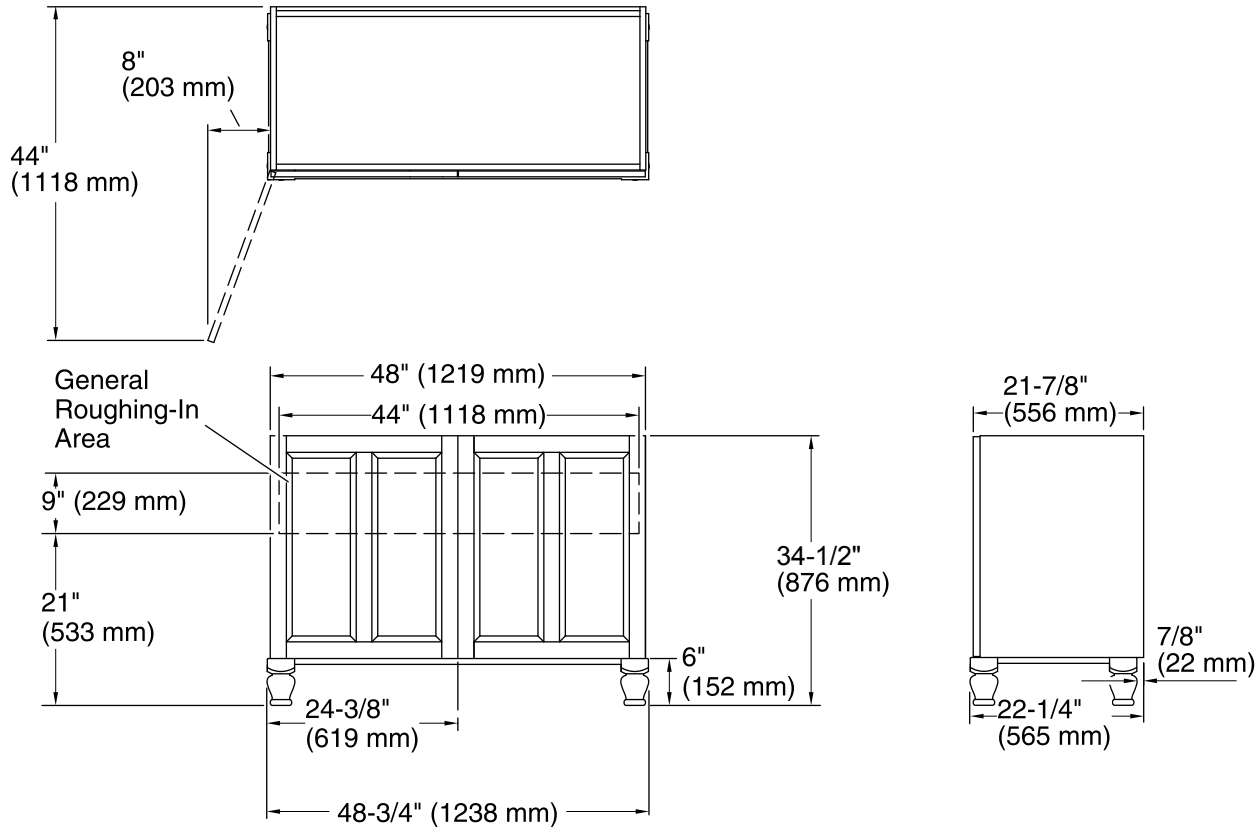

Technical Information

All product dimensions are nominal.

Vanity type: Standard

Notes

Install this product according to the installation guide.

Decorative cabinet hardware is not supplied. Refer to the KOHLER bath accessories line for recommended cabinet hardware to complement your vanity.

Select the type of fastener based upon the wall material. Two 250 lb (113.4 kg) minimum load bearing fasteners are recommended.