



Features

- Low-threshold design for easy entry and exit.
- Recessed rear drain.
- Single threshold for three-wall or alcove installation.
- Durable acrylic construction.
- Requires K-9333 Groove aluminum drain cover or K-9337 Groove teak drain cover (sold separately).

Required Products/Accessories

K-9333 Drain Cover

or

K-9337 Drain Cover

Recommended Products/Accessories

K-9132 Shower Drain



Codes/Standards

CSA B45.5/IAPMO Z124

ASTM E162

ASTM E662

Greenguard UL 2818 - Gold







KOHLER® Plastic Baths and Receptors Lifetime Limited Warranty

See website for detailed warranty information.

Available Colors/Finishes

Color tiles intended for reference only.

Color	Code	Description
-------	------	-------------

	0	White
	96	Biscuit
	47	Almond
	NY	Dune
	95	Ice™ Grey
	G9	Sandbar

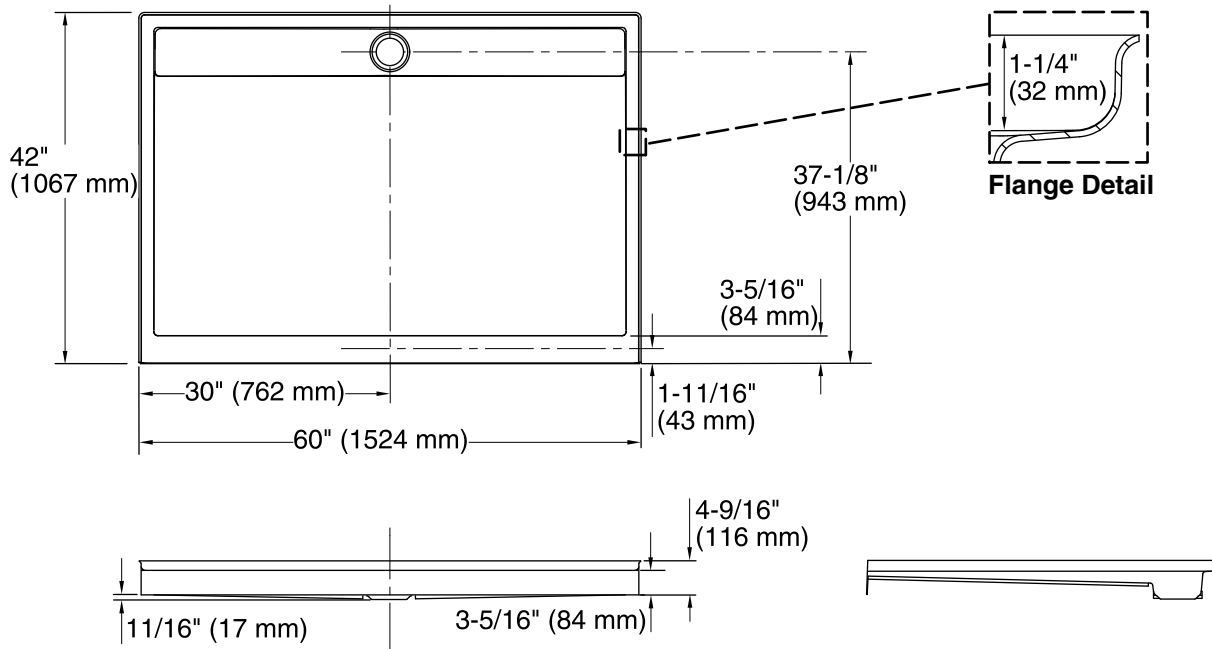

Technical Information

All product dimensions are nominal.
 Installation: Three-wall alcove
 Drain location: Center rear
 Weight: 72 lbs (32.7 kg)
 Minimum floor load: 20 lbs/ft² (97.6 kg/m²)

Notes

Measure your actual product for rough-in details. Install this product according to the installation instructions. Shimming may be required to level the fixture. Shimming may be required between the stud frame and the fixture. Stud opening tolerance is + 1/4" (6 mm), - 0" (0 mm).